

Technical sheet :

MI 70 D ST5



Technical characteristics			Metric
1.1	Manufacturer		MANITOU
1.2	Model Name		MI 70 D ST5
1.3	Power source		Diesel
1.4	Operator type		Seated
1.5	Max. capacity	Q	7000 kg
1.6	Load centre of gravity	c	600 mm
1.8	Load distance, centre of drive axle to fork	x	603 mm
1.9	Wheelbase	y	2300 mm
Weight			
2.1	Service Weight		10110 kg
2.2	Weight on front axle (laden) / rear axle (laden)		15290 kg / 1820 kg
2.3	Weight on front axle (Unladen) / rear axle (Unladen)		4120 kg / 5990 kg
Wheels			
3.1	Tyres type		Super Elastic
3.2	Dimensions of front wheels		8.25-15 14PR
3.3	Dimensions of rear wheels		8.25-15 14PR
3.5	Number of front wheels / rear wheels		4 / 2
3.2	Number of drive wheels		4
3.6	Front wheel gauge	b10	1489 mm
3.7	Rear wheel gauge	b11	1700 mm
Dimensions			
4.1	Tilt of Mast Forward (deg) / Backward (deg)	α / β	6 / 12
4.7	Height of overhead guard (cabin)	h6	2430 mm
4.8	Seat height/stand height	h7	1350 mm
4.12	Height of towing bar (coupling height)	h10	710 mm
4.19	Overall length	l1	4804 mm
4.20	Length to face of forks	l2	3604 mm
4.21	Overall width	b1	1990 mm
4.22	Forks section / width / length	s / e / l	65 mm x 150 mm / 1220 mm
4.23	Fork carriage ISO 2328 (class/form) A/B		FEM 4A
4.24	Fork carriage width	b3	1700 mm
4.31	Ground clearance below mast	m1	190 mm
4.32	Ground clearance at centre of wheelbase	m2	270 mm
4.33	Aisle width for 1000 x 1200 pallet widthways	Ast	5150 mm
4.34	Aisle width for 800 x 1200 pallet lengthways	Ast	5350 mm
4.35	Turning radius	Wa	3330 mm
4.36	Internal turning radius (over tyres)	b13	110 mm
Performances			
5.1	Travel speed (laden / unladen)		23 km/h / 24 km/h
5.2	Lifting speed (laden / unladen)		0.36 m/s / 0.41 m/s
5.3	Lowering speed (laden / unladen)		0.48 m/s / 0.42 m/s
5.5	Drawbar pull (Laden / Unladen)		6500 daN / 2750 daN
5.7	Gradeability - laden / unladen		20 % / 20 %
5.9	Service brake		Hydraulic

Engine			
7.1	Engine brand / model / norm		Deutz / TCD 3.6 L4 / Stage V
7.2	Engine power according to ISO 1585		55,4 kW
7.3	Rated speed		2300 tr/min
7.4	Number of cylinders / Capacity of cylinders		4 - 3621 cm ³
	Fuel consumption according to VDI cycle		12 l/h
Miscellaneous			
8.2	Working hydraulic pressure for attachments		190 Bar
8.3	Oil flow rate for attachments		165 l/min
8.4	Measured/guaranteed mean noise level at the ear of the operator		< 84 dB(A)

Dimensional drawing

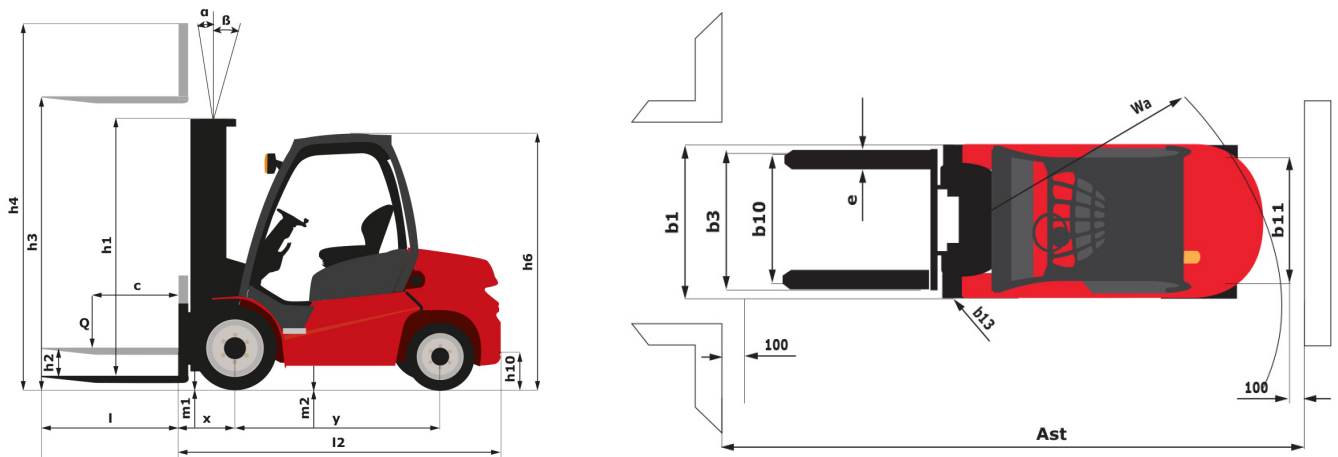

Characteristics of masts and residual capacities

Full Visibility Duplex		FVD 30	FVD 33	FVD 36	FVD 40	FVD 45	FVD 50
h2 - Free lift	mm	160	160	160	160	160	160
h1 - Height mast lowered *	mm	2500	2650	2800	3000	3300	3550
h3 - Lifting Height	mm	3000	3300	3600	4000	4500	5000
h4 - Height mast extended *	mm	4167	4467	4767	5167	5667	6167
α / β - Mast inclination (front / rear)	°	6 / 12	6 / 12	6 / 12	6 / 12	6 / 6	6 / 6
Residual capacity without attachment (Industrial load chart)	kg	7000	7000	7000	7000	7000	7000
Residual capacity with hooked-on side shift (Industrial load chart)	kg	6500	6500	6500	6500	6500	6500
Height at max capacity	mm	3000	3300000	3600	4000	4500	5000
Height at max capacity with hooked-on sideshift	mm	3000	3300	3600	4000	4500	5000

Free Lift Duplex		FLD 30	FLD 33	FLD 36	FLD 40
h2 - Free lift	mm	1335	1485	1635	1835
h1 - Height mast lowered *	mm	2450	2600	2750	2950
h3 - Lifting Height	mm	3000	3300	3600	4000
h4 - Height mast extended *	mm	4115	4415	4715	5115
α / β - Mast inclination (front / rear)	°	6 / 12	6 / 12	6 / 12	6 / 12
Residual capacity without attachment (Industrial load chart)	kg	7000	7000	7000	7000
Residual capacity with hooked-on side shift (Industrial load chart)	kg	6500	6500	6500	6500
Height at max capacity	mm	3000	3300	3600	4000
Height at max capacity with hooked-on sideshift	mm	3000	3300	3600	4000

Free Lift Triplex		FLT 45	FLT 48	FLT 50	FLT 55	FLT 60
h2 - Free lift	mm	1500	1600	1672	1800	2000
h1 - Height mast lowered *	mm	2725	2825	2875	3075	3225
h3 - Lifting Height	mm	4500	4800	5000	5500	6000
h4 - Height mast extended *	mm	5735	6035	6213	6785	7235
α / β - Mast inclination (front / rear)	°	6 / 6	6 / 6	6 / 6	3 / 6	3 / 6
Residual capacity without attachment (Industrial load chart)	kg	6400	6300	6300	6100	5500
Residual capacity with hooked-on side shift (Industrial load chart)	kg	5900	5800	5800	5600	5000

Free Lift Triplex		FLT 45	FLT 48	FLT 50	FLT 55	FLT 60
Height at max capacity	mm	4500	4800	5000	5500	6000
Height at max capacity with hooked-on sideshift	mm	4500	4800	5000	5500	6000



Siège Social

430 rue de l'Aubinière - 44150 Ancenis Cedex - France

Tel: +33(0)2 40 09 10 11 - Fax: +33 (0)2 40 09 10 97

www.manitou.com



This brochure describes versions and configuration options for Manitou products which may be fitted with different equipment. The equipment described in this brochure may be standard, optional or not available depending on version. Manitou reserves the right to change the specifications shown and described at any time and without prior warning. The manufacturer is not liable for the specifications given. For more information, contact your Manitou dealer. Non-contractual document. Product descriptions may differ from actual products. List of specifications is not comprehensive. The logos and visual identity of the company are the property of Manitou and may not be used without authorisation. All rights reserved. The photos and diagrams contained in this brochure are provided for information only.

MANITOU BF SA - Limited company with board of directors - Share capital: 39,668,399 euros - 857 802 508
RCS Nantes